

# Between Us Dining Chair

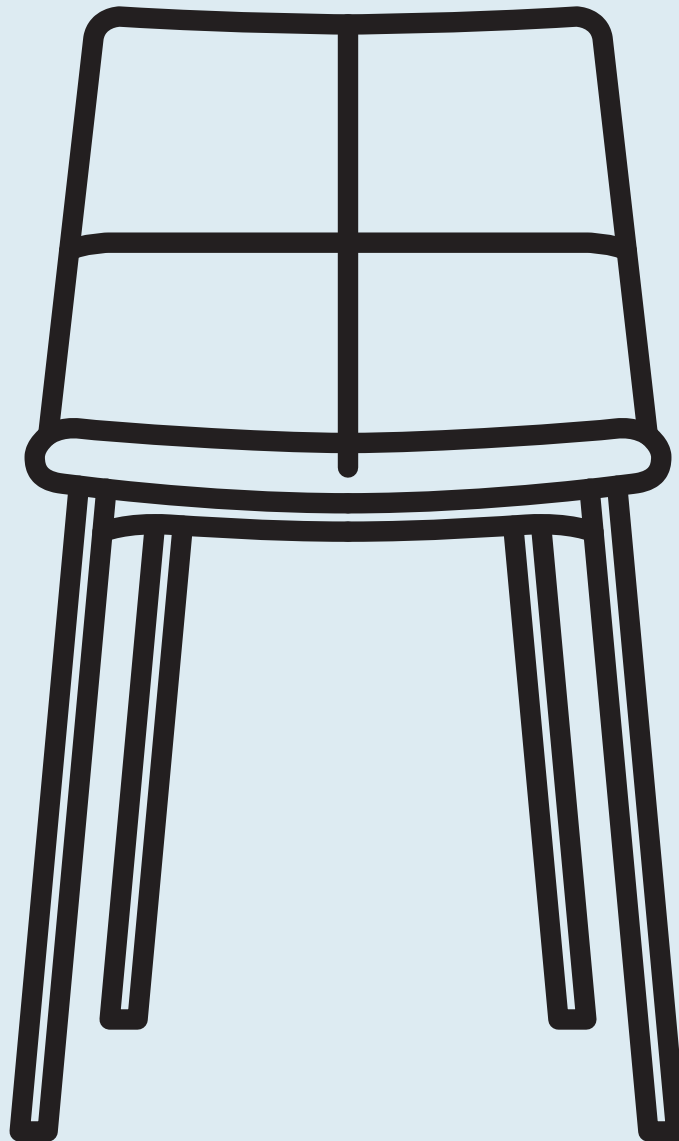

DESIGNED IN 2017

ASSEMBLY NOTES | REV 01



## FRIEND WITH BENEFITS.

Rectangular steel legs bring a bit of edge and grid stitched upholstered seat and back lend texture and softness to this seating situation.

## NEED A HAND?

Contact us at [service@bludot.com](mailto:service@bludot.com) or **844.425.8368** for assistance.

# Parts & Hardware

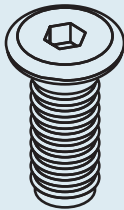

QTY 4

PT. 1081

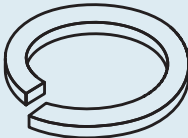

QTY 4

PT. 3001



QTY 1

PT. 9026

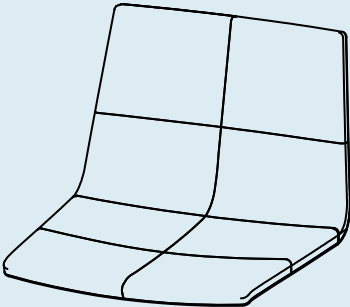

QTY 1

Shell

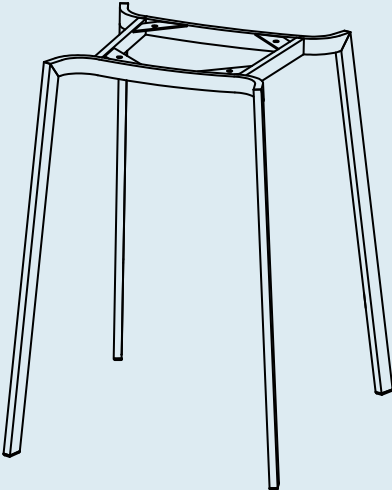

QTY 1

Base

# Step 01

ATTACH BASE TO SHELL.

Attach the base to the shell as shown using the provided hardware.

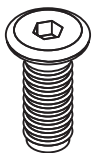
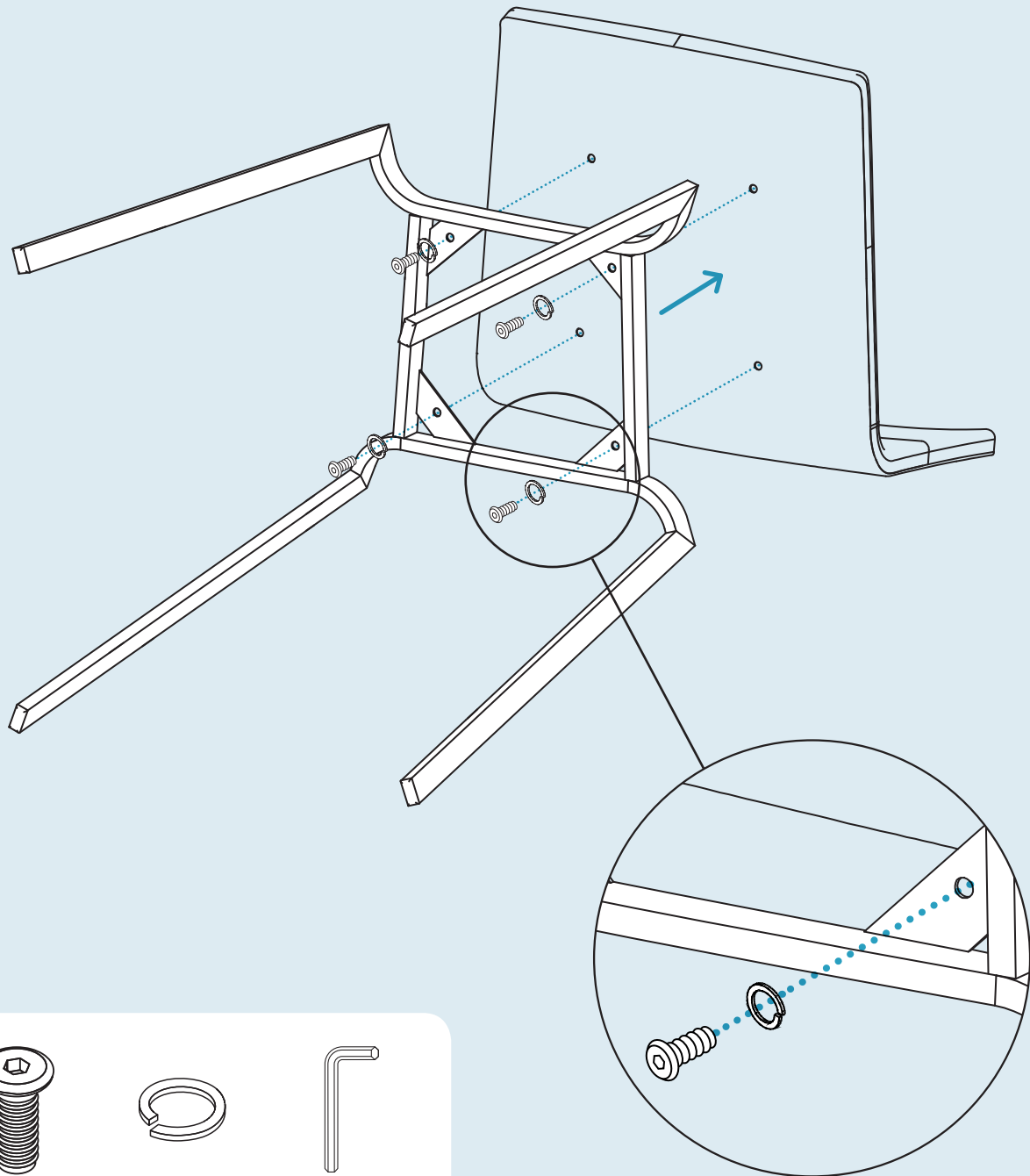

PT. 1081 x 4

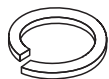

PT. 3001 x 4

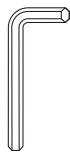

PT. 9026 x 1

## Additional Information

### CLEAN

Vacuum your upholstery regularly. For leather furniture dust regularly with a dry cloth.

### SPILLS

Act quickly with spills. Absorb the spill with a clean white cloth or paper towel. Never rub the surface. Do not use water or other liquids to clean, as they may cause stains. Consult a commercial cleaning specialist for removal of stubborn stains.

### AVOID

Keep furniture out of direct sunlight and away from heat sources; excessive exposure to sunlight may cause color fading. Avoid placing heavy or sharp objects on the furniture surface for long periods of time; this can cause permanent surface indentations. For snags in the fabric, tuck loose threads into fabric or carefully push to reverse side. Never pull out or cut off loose threads.

