

Rune Leaning Mirror

DESIGNED IN 2016

ASSEMBLY NOTES | REV 01

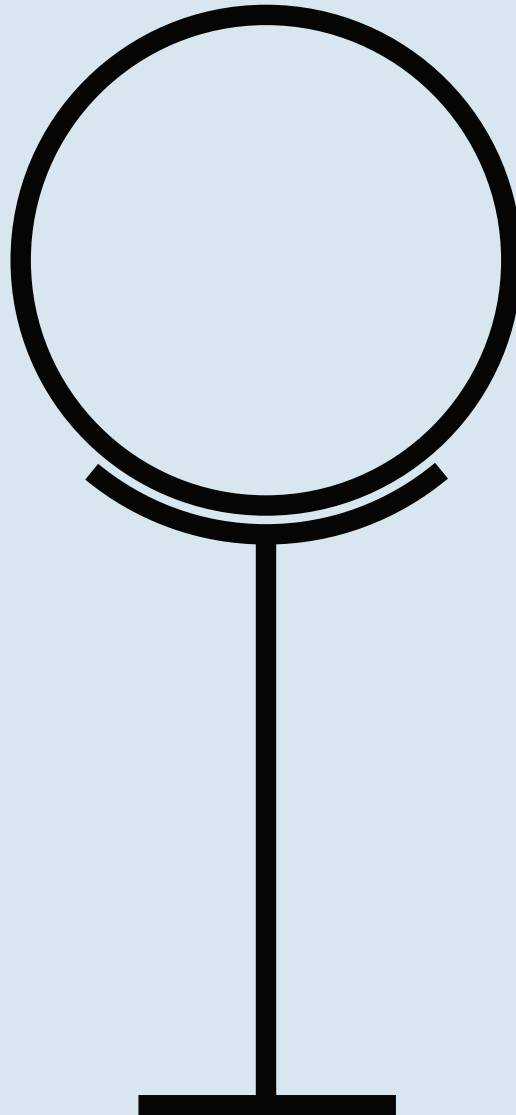
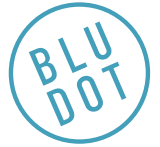

DON'T LET YOUR FACE RUNE YOUR DAY.

Sculpture and function meet in Rune. A round mirror with a slim tubular steel frame rest daintily on your wall to provide a suave and stunning way to make sure you don't have spinach in your teeth.

NEED A HAND?

Contact us at service@bludot.com or **844.425.8368** for assistance.

Parts & Hardware

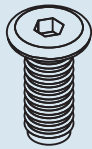

QTY

4

QTY

Pt. 1603

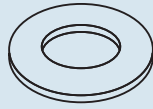

4

Pt. 3002



QTY

3

Pt. 1219

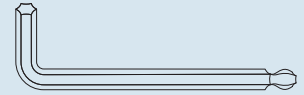

QTY

1

Pt. 9018

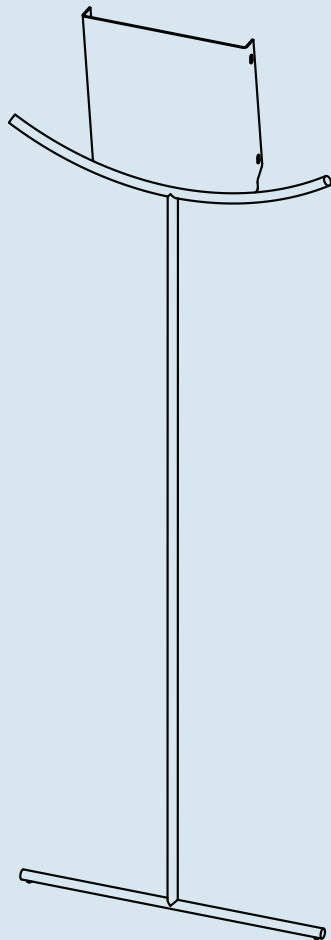

QTY

1

Base

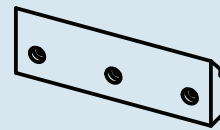

QTY

1

Cleat

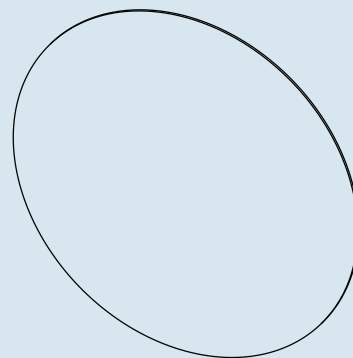

QTY

1

Mirror

Step 01

ATTACH CLEAT.

Attach cleat to wall using provided hardware as shown.

Though fasteners are provided, consult your local hardware professional to determine the hardware best suited for your type of wall.

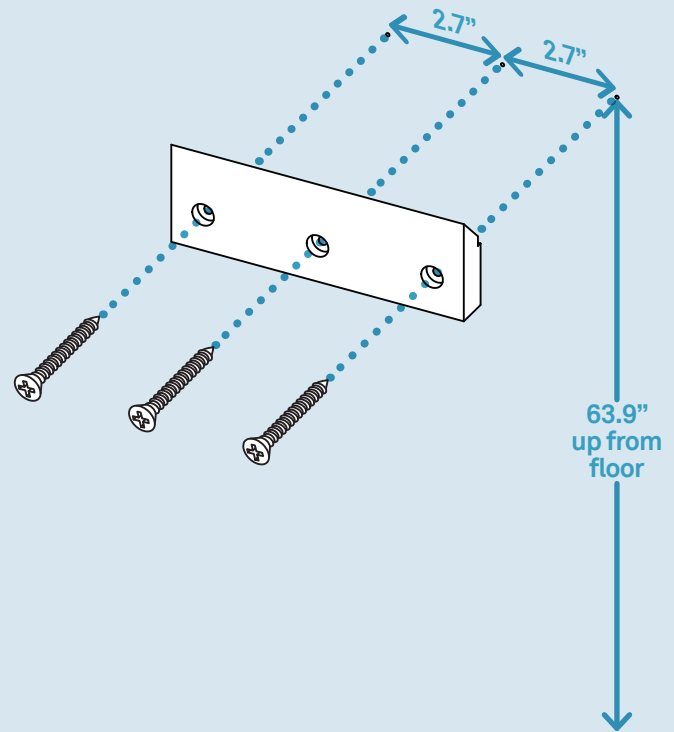
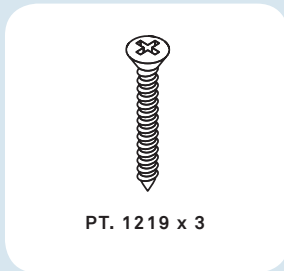

Step 02

ATTACH BASE.

Attach base to mirror using the provided hardware as shown. Use the shipping box as a work surface to aid in assembly.

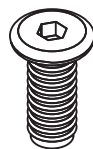
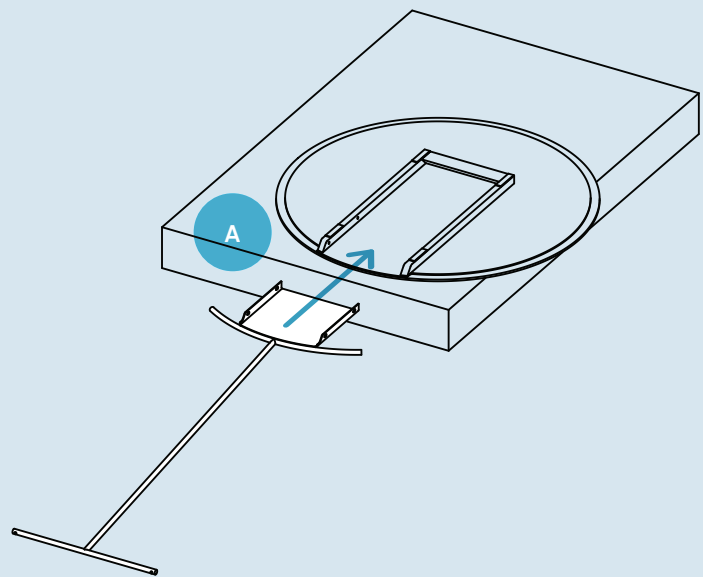
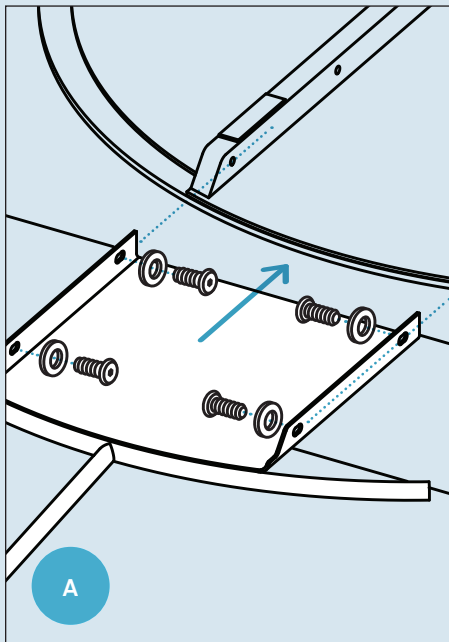

Pt. 1603 x 4

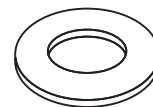

Pt. 3002 x 4



Pt. 9018 x 1

Step 03

POSITION ON WALL.

Position mirror above attached cleat and slide down along wall to lock into place.

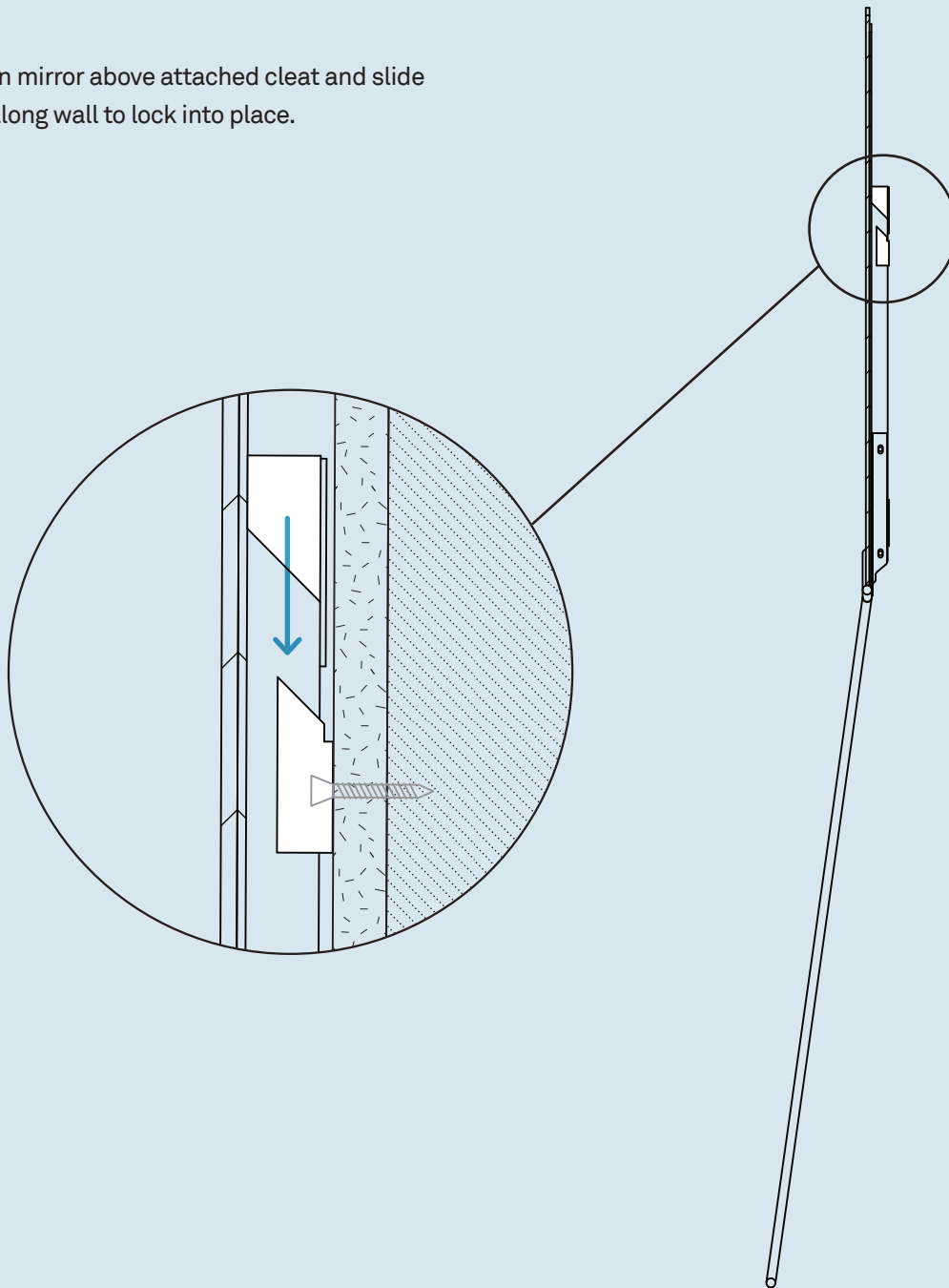

Additional Information

CLEAN

Clean with a slightly damp, soft cloth. To remove dirt and fingerprints, use a quality glass cleaner. Wipe completely dry with a soft cloth.

